

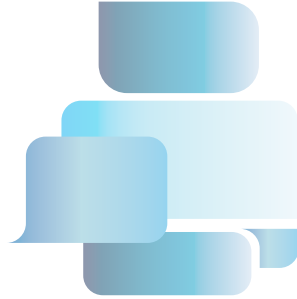

FILTER TECHNOLOGY

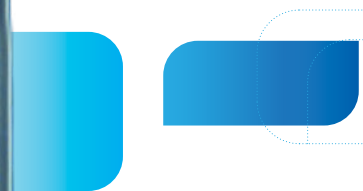

ABLU SUPREME



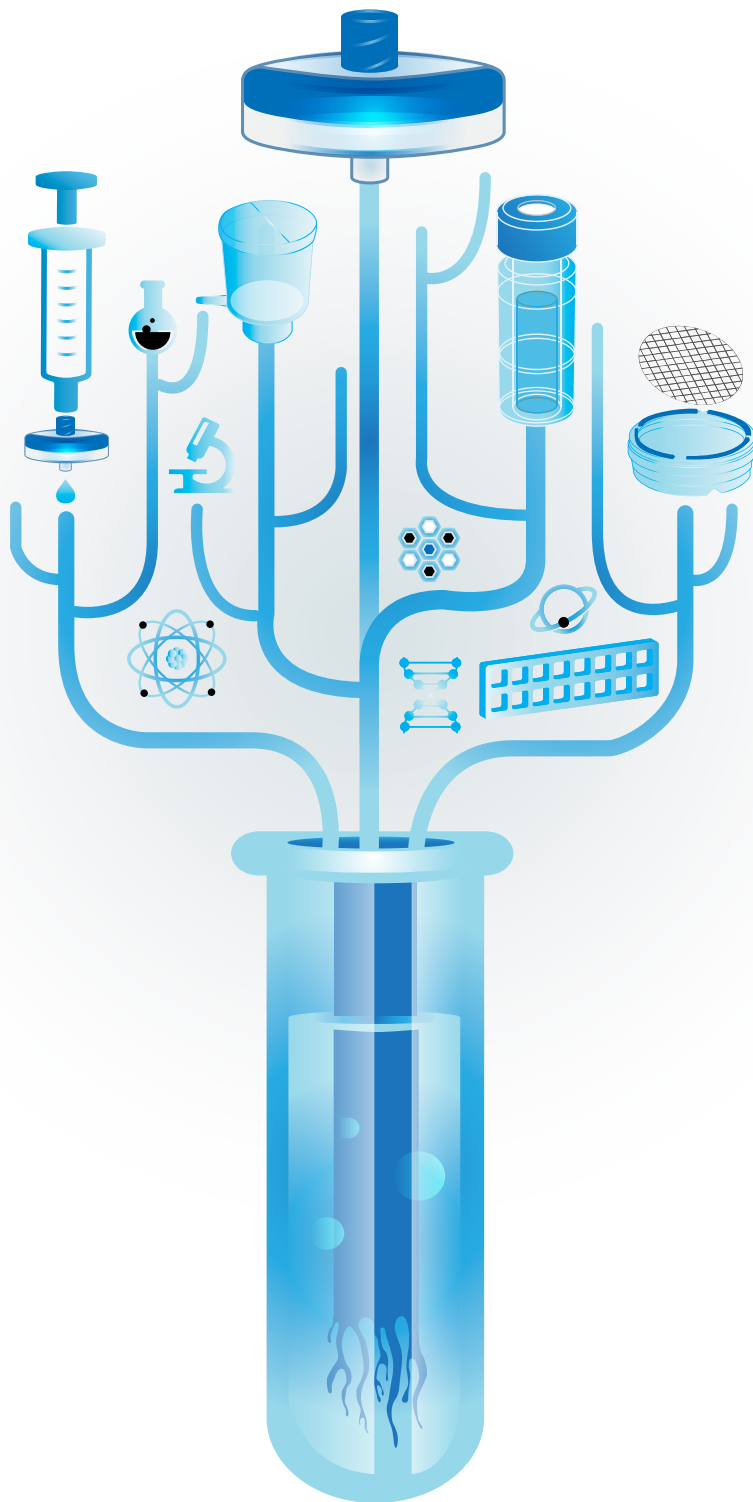

The GVS Group is one of the world's leading manufacturers of filter solutions for applications in the Healthcare & Life Sciences, Energy & Mobility and Health & Safety sectors. GVS technology promotes health and safety in highly regulated environments. Throughout its 40-year history, GVS has evolved from a supplier of components for the healthcare sector to a global Group that provides a range of diversified, high-tech filtration solutions.

ABLUO SUPREME



NEW ABLUO SUPREME SYRINGE FILTER

Step up your sample preparation with GVS ABLUO SUPREME Syringe Filters

GVS offers a range of disposable syringe filter devices designed to provide fast and efficient filtration of aqueous and organic solutions with high particulate content.

GVS Standard vs Supreme water recovery

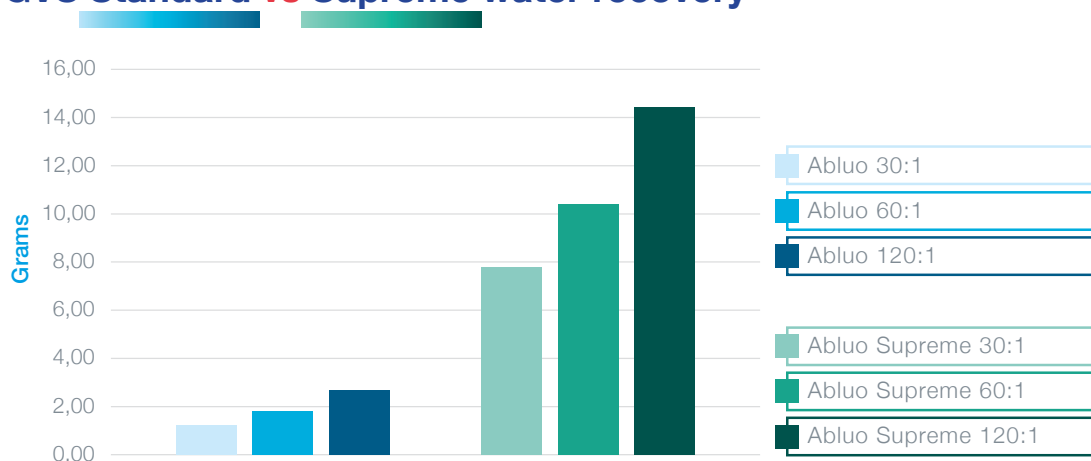

What's Special:

- ◆ Supreme Purification: Easily separate sediment and grit from samples, ensuring quality, and leaving you with the purest sample for your application.
- ◆ Supreme Flexibility: A full portfolio of products with various pore sizes, sterility options, and membranes available (including Hydrophilic PTFE)!
- ◆ Supreme Strength: Our most durable and robust syringe filter, the ABLUO SUPREME allows for the filtration of the heaviest sediment, resulting in a pure sample every time.
- ◆ Save Money: Use 1 ABLUO SUPREME in the place of 3 (or more) normal syringe filters!
- ◆ Save Operator Time and Effort: Two layers of pre-filter allow for the use of less force, making filtration faster and easier for lab techs!
- ◆ Save Sleep: Rest easy knowing that the ABLUO SUPREME Syringe Filter is made to conform to ISO standards.
- ◆ Save the environment: By using the ABLUO SUPREME, you are able to do the work of 5 and more normal syringe filters. Additionally, some ABLUO SUPREME models are compatible with an autoclave, meaning less plastic waste.

Technical Specifications

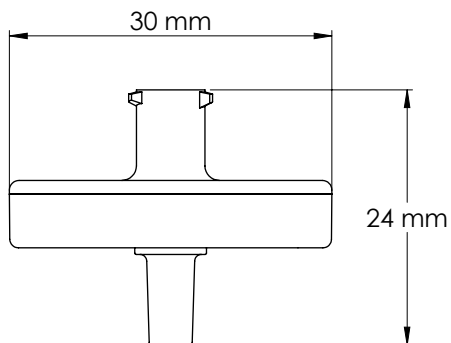

Membrane Diameter: 25 mm
Effective Filtration Area: 4.63 cm²
Housing Diameter: 30 mm
Housing Materials: Clear Polypropylene
Maximum Operating Temperature: 90°C / 194°F
Maximum Operating Pressure: 75 psi
Shelf Life (normal conditions): 3 years

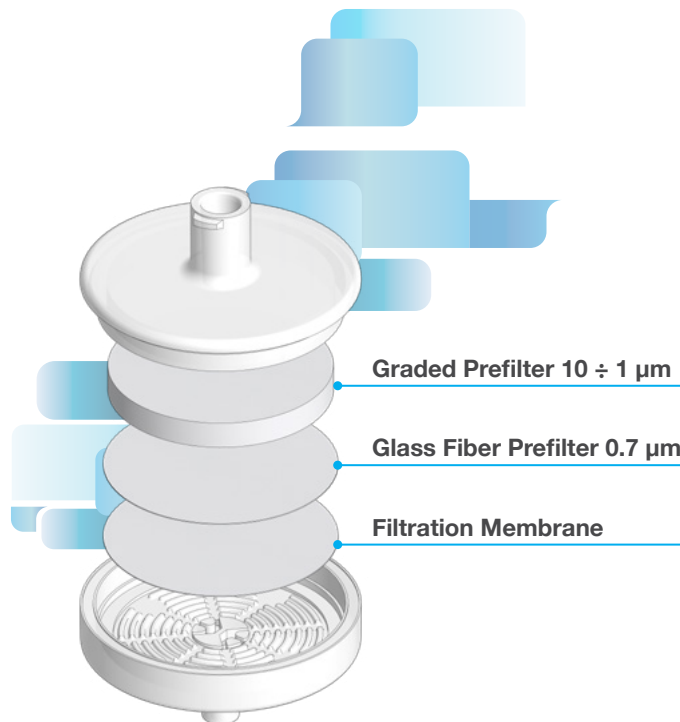

Ordering information

Membrane	Pore Size (µm)	Description	Product Code
NY	0.2	ABLUO SUPREME Syringe Filter 25mm, FLL/MLS - NY 0.2 µm	GF25BNPGN002AD01
NY	0.45	ABLUO SUPREME Syringe Filter 25 mm, FLL/MLS - NY 0.45 µm	GF25BNPGN004AD01
PES	0.2	ABLUO SUPREME Syringe Filter 25 mm, FLL/MLS - PES 0.2 µm	GF25BNPGS002AD01
PES	0.45	ABLUO SUPREME Syringe Filter 25 mm, FLL/MLS - PES 0.45 µm	GF25BNPGS004AD01
PTFE	0.2	ABLUO SUPREME Syringe Filter 25mm, FLL/MLS - PTFE 0.2 µm	GF25BNPGT002AD01
PTFE	0.45	ABLUO SUPREME Syringe Filter 25 mm, FLL/MLS - PTFE 0.45 µm	GF25BNPGT004AD01
PTFE (Hydrophilic)	0.2	ABLUO SUPREME Syringe Filter 25mm, FLL/MLS - PTFE Hydrophilic 0.2 µm	GF25BNPGH002AD01
PTFE (Hydrophilic)	0.45	ABLUO SUPREME Syringe Filter 25 mm, FLL/MLS - PTFE Hydrophilic 0.45 µm	GF25BNPGH004AD01
PVDF	0.2	ABLUO SUPREME Syringe Filter 25 mm, FLL/MLS - PVDF 0.2 µm	GF25BNPGV002AD01
PVDF	0.45	ABLUO SUPREME Syringe Filter 25 mm, FLL/MLS - PVDF 0.45 µm	GF25BNPGV004AD01
CA	0.2	ABLUO SUPREME Syringe Filter 25 mm, FLL/MLS - CA 0.2 µm	GF25BNPGA002AD01
CA	0.45	ABLUO SUPREME Syringe Filter 25 mm, FLL/MLS - CA 0.45 µm	GF25BNPGA004AD01

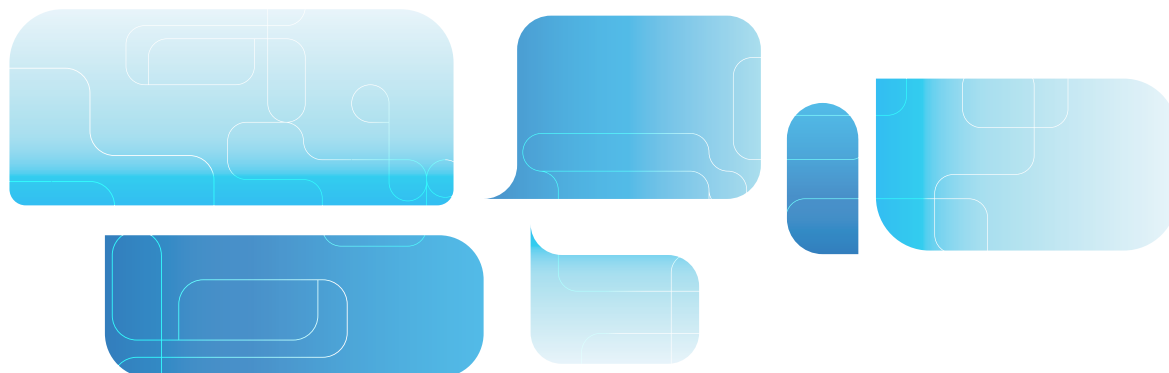



Applications

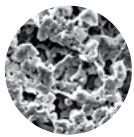

NY

Properties

Hydrophilic - Low protein binding -
Superior strength - Resistant to organic solvents

Compounds Class

Bases, HPLC solvents, alcohols,
aromatic hydrocarbons

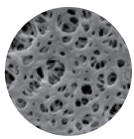

PES

Properties

Hydrophilic - Designed to remove particulates - Low
protein and drug binding - High strength and durability

Compounds Class

Filtration of buffers and culture media

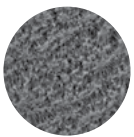

PTFE

Properties

Hydrophobic - Chemically and biologically inert
- Superior chemical resistance

Compounds Class

Organic solvents, acids, alcohols, bases, aromatics

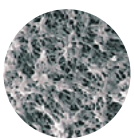

PTFE (Hydrophilic)

Properties

Hydrophilic - High chemical resistance - Low
protein binding

Compounds Class

Aqueous and organic solutions

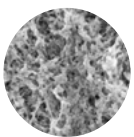

PVDF

Properties

Hydrophilic - Very low protein binding -
High flow rates

Compounds Class

Alcohols, biomolecules

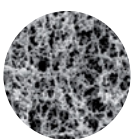

CA

Properties

Hydrophilic - Low non-specific binding - Low
adsorption - Uniform pore structure

Compounds Class

Protein/Enzymes, protein recovery, tissue culture
media filtration, wine filtration, pre-filtration of plasma
fractions and vaccines

How to use - Operating Instructions

- ◆ **1.** Remove a syringe filter from its box or container. If using a sterile filter please check that the individual package has not been damaged. Peel the protective lid and hold the filter in one hand without removing it from the blister.
- ◆ **2.** Prepare the sample to be filtered and place it in a syringe. If using a syringe smaller than 10 ml, please proceed with caution as these syringes can generate an injection pressure exceeding the maximum pressure the filter can withstand.
- ◆ **3.** Firmly connect the syringe to the female luer-lock filter connection. If using a needle, tip or accessory connected to the male luer-lock filter connection, be sure the connection has been made properly.
- ◆ **4.** Hold the syringe in a vertical position, with the filter up, and proceed to slowly advance the plunger until the liquid exits from the filter outlet. This will allow purging the air content in the syringe filter and promote the proper wetting of the membrane.
- ◆ **5.** Filter the contents of the syringe and collect it into a flask or suitable container.
- ◆ **6.** Once the filtration is complete, discard the filter according to the legal requirements for single use products

Chemical compatibility:

Chemical	Filter Media												Housing				
	ca	nc	pes	ny	ptu	ptl	pvd	rc	gfb	gfn	ag	pc	pet	ac	ps	pst	pp
Chloroform	N	R	N	NR	R	L	R	R	R	R	R	N	R	N	L	N	L
Cyclohexane	R	R	T	R	R	R	T	R	R	R	R	R	R	N	R	T	R
Cyclohexanone	N	N	N	T	R	R	N	R	R	R	R	L	T	N	N	N	R
Diethyl Acetamide	N	N	T	R	R	N	T	R	R	R	R	NR	NR	N	N	N	T
Dimethyl Formamide	N	N	N	R	R	R	N	L	N	R	R	NR	NR	N	N	N	R
Dimethyl Sulfoxide (DMSO)	N	N	N	R	R	R	N	R	N	R	T	N	R	N	N	N	T
Dioxane	N	N	L	R	R	R	R	R	R	R	R	N	R	N	N	N	R
Ethyl Ether	L	L	R	R	R	R	R	T	R	R	R	R	R	N	L	N	N
Ethylene Dichloride	L	L	T	R	R	R	T	T	R	R	R	N	R	T	N	T	T
Formaldehyde	L	N	R	R	R	R	R	T	R	R	R	R	R	N	R	N	R
Freon TF	R	R	R	R	R	R	R	T	R	R	R	R	R	L	R	N	T
Gasoline	R	R	T	R	R	R	R	R	R	R	R	R	R	N	R	N	N
Hexane	R	R	T	R	R	R	R	R	L	R	R	R	R	N	R	N	T
Isopropyl Acetate	N	N	T	R	R	R	N	R	N	R	R	R	R	N	N	N	R
Kerosene	R	R	T	R	R	R	R	R	R	R	R	R	R	N	N	N	T
Methyl Acetate	N	N	T	R	R	R	R	R	N	R	R	N	R	N	N	N	R
Methyl Ethyl Ketone (MEK)	N	N	N	R	R	R	NR	R	R	R	R	NR	R	N	N	N	T
Methyl Isobutyl Ketone	N	N	T	R	R	R	N	R	R	R	R	NR	T	N	N	N	T
Methylene Chloride	N	N	N	T	R	R	R	NR	R	R	R	N	NR	N	N	N	N
Nitrobenzene	N	N	N	T	R	R	R	NR	N	N	T	N	NR	N	N	N	R
Pentane	R	R	R	R	R	L	R	NR	R	R	R	R	R	N	R	N	T
Perchloroethylene	R	R	N	R	R	R	T	R	N	N	R	T	T	N	L	N	L
Pyridine	N	N	N	T	R	R	N	R	N	R	R	N	T	N	N	N	L
Tetrahydrofuran	N	N	N	T	L	L	N	R	T	L	R	N	T	N	N	N	L
Toluene	L	R	N	R	R	L	R	R	N	R	R	L	R	N	N	N	L
Trichloroethane	L	N	L	T	R	R	T	NR	T	T	R	N	T	N	N	N	T
Trichloroethylene	R	R	R	T	L	L	R	R	N	N	R	B	ND	N	N	N	N
Triethylamine	R	L	T	R	R	R	T	R	R	R	R	L	R	T	N	T	T
Xylene	R	R	L	T	R	L	R	R	R	R	R	NR	NR	N	N	N	R

SOLVENTS

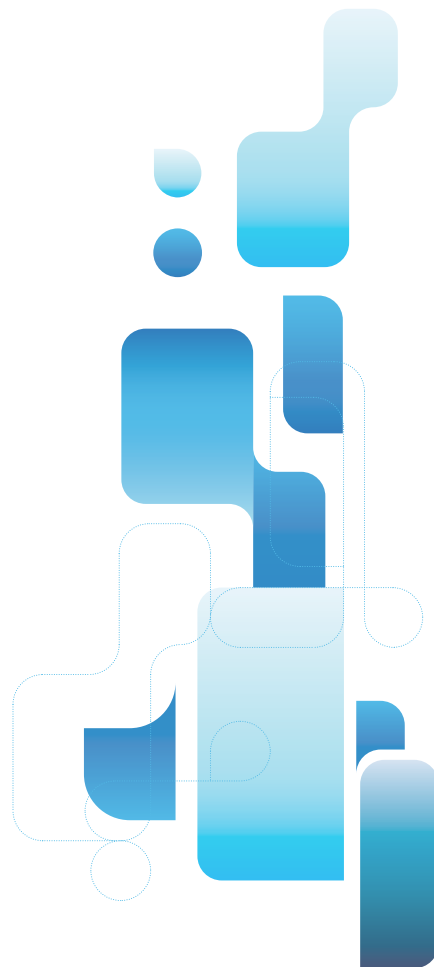

Quality guarantee: Product totally produced in a clean room under quality criteria according the ISO 9001:2008 norms. Quality control on 100% of the production.

The use of GVS products in specific applications may give varying results, according to the specific conditions and applications. GVS assumes no responsibility for damages resulting from the incorrect use of its products.

© Copyright 2022 GVS Group - All rights Reserved
For further information, please visit www.gvs.com



WORLDWIDE DISTRIBUTION CENTERS

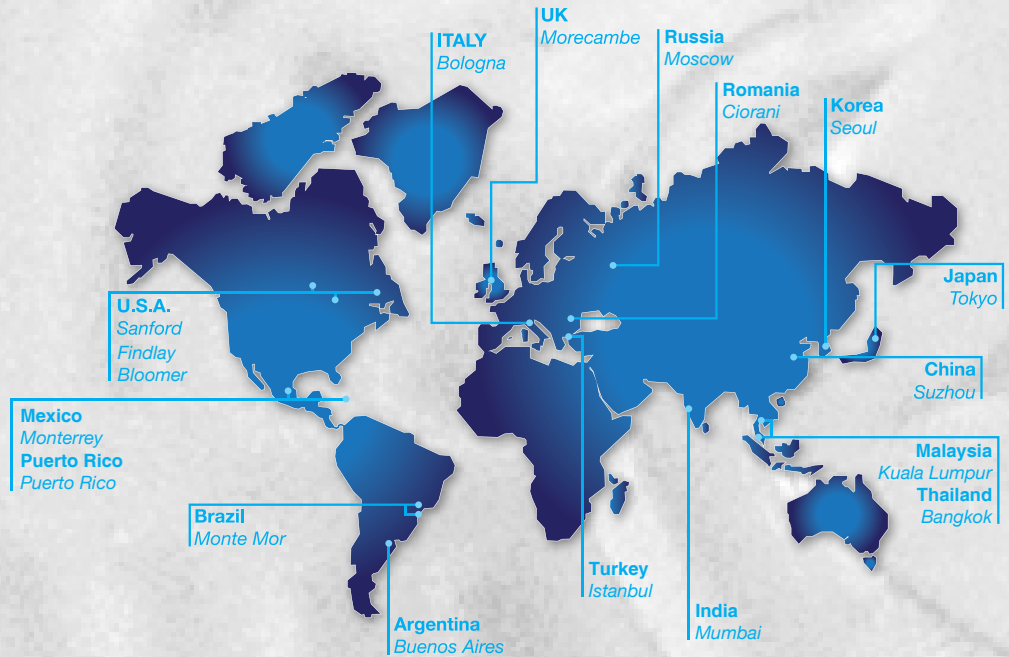

EUROPE

Italy Office
Headquarters
GVS S.p.A.
Via Roma 50
40069 Zola Predosa (BO) - Italy
Tel. +39 051 6176311
Fax +39 051 6176200
lifesciences.it@gvs.com

United Kingdom
GVS Filter Technology UK Ltd.
NFC House
Vickers Industrial Estate
Mellishaw Lane, Morecambe
Lancashire LA3 3EN
Tel. +44 (0) 1524 847600
lifesciences.uk@gvs.com

Russia
GVS Russia LLC
Profsoyuznaya Street, 25-A, office 102
117418, Moscow
Russian Federation (Russia)
Tel. +7 495 0045077
lifesciences.ru@gvs.com

Romania
GVS Microfiltrazione srl
Sat Ciorani de Sus 1E
107156 Ciorani
Prahova Română
Tel. +40 244 463044
lifesciences.ro@gvs.com

Turkey
GVS Türkiye
Cevizli mah. Zuhul cad. Ritim Istanbul
no: 44 A-1 Blok D.371 Maltepe / Istanbul
Tel. +90 216 504 47 67
lifesciences.tr@gvs.com

ASIA

China
GVS Technology (Suzhou) Co., Ltd.
Fengqiao Civil-Run Sci-Tech Park,
602 Changjiang Road, S.N.D.
Suzhou, China 215129
Tel. +86 512 6661 9880
Fax: +86 512 6661 9882
lifesciences.cn@gvs.com

Japan
GVS Japan K.K.
KKD Building 4F, 7-10-12 Nishishinjuku
Shinjuku-ku, Tokyo 160-0023 Japan
Tel. +81 3 5937 1447
Fax +81 3 5937 1448
lifesciences.jp@gvs.com

Korea
GVS Korea Ltd #315 Bricks Tower
368 Gyungchun-ro(Gaun-dong),
472060 Namyangju-si, Gyunggi-do
Tel: +82 31 563 9873
Fax: +82 31 563 9874
lifesciences.kr@gvs.com

India
GVS Filter India Pvt Ltd
Unit No 35 & 36 on First Floor
Ratna Jyot Industrial Premises Irla Lane,
Irla Vile Parle, Mumbai 400056, India
lifesciences.in@gvs.com

Malaysia
GVS Filtration Sdn.Bhd
Lot No 10F-2B, 10th Floor, Tower 5 @ PFCC
Jalan Puteri 1/2, Bandar Puteri
47100 Puchong, Selangor, Malaysia
Tel: +60 3 7800 0062
lifesciences.my@gvs.com

Thailand
GVS Filtration Co., Ltd.
88 Ratchadaphisek Rd,
Office 10E03 - Khlong Toei,
Bangkok 10110
lifesciences.th@gvs.com

AMERICA

U.S.A.
GVS North America, Inc.
63 Community Drive
Sanford, ME 04073 - USA
Tel. +1 866 7361250
lifesciences.us@gvs.com

Puerto Rico
GVS Puerto Rico, LLC
98 Carr 194 - Fajardo,
Puerto Rico, 00738-2988, USA
Tel. +1.787.355.4100
e-mail: gvspuertorico@gvs.com

Mexico
GVS de México
Universal No. 550, Vynmsa Aeropuerto Apodaca
Industrial Park, Ciudad Apodaca, Nuevo León,
C.P. 66626 México
Tel. +52 81 2282 9003
lifesciences.mx@gvs.com

Brazil
GVS do Brasil Ltda.
Rodovia Conego Cyriaco Scaranello Pires 251
Jardim Chapadão, CEP 13193-580
Monte Mor (SP) - Brasil
Tel. +55 19 38797200
Fax +55 19 38797251
lifesciences.br@gvs.com

Argentina
GVS Argentina S.A.
Francisco Acuña de Figueroa
719 Piso:11 Of: 57
1416 Buenos Aires - Argentina
Tel. + 5411 48614750
lifesciences.ar@gvs.com